



Electrolux
PROFESSIONAL

Eco Preparation 1000 mm Worktop Cupboard

ITEM # _____

MODEL # _____

NAME # _____

SIS # _____

AIA # _____



132856 (MS1007N)

WorkTop Cupboard,
1000mm

Short Form Specification

Item No. _____

Made entirely from stainless steel. Inner welded frame in stainless steel. Unique connection of panels to inner frame. Worktop in 304 AISI stainless steel (50mm high) incorporates a layer of sound deadening material and has upturned edges. Sound-deadened

Main Features

- Ideal for central positioning in the kitchen, either as island installation or back to back.
- Handles in stainless steel for better hygiene and reliability.
- Sturdiness, stability and reliability of table accurately tested.

Construction

- Inner welded frame in stainless steel to guarantee superior strength and stability.
- Handles directly built into the sliding doors.
- Equipped with intermediate shelf which can be positioned at three different heights.
- Intermediate shelf in stainless steel with riveted corners and trasversal reinforcement in stainless steel.
- Sturdy sound-deadened sliding doors on tracks located flush to the front of the frame.
- Easy access to the cupboard interior on all lengths guaranteed by the use of only 2 doors.
- Constructed entirely in stainless steel to offer maximum durability.
- Constructed entirely in stainless steel to offer maximum durability.
- Base panel has 40mm high profile, is 8/10 in thickness with upturned edges and bar reinforcement. It is welded to legs for further structure reinforcement.
- 304 AISI stainless steel feet, 150 mm high and 54 mm in diameter, adjustable by -35/+25 mm.
- 50 mm worktop in 304 AISI stainless steel.

Optional Accessories

- Wheel kit for cupboards, 4 wheels (2 with brakes), D=100 mm PNC 855299

APPROVAL: _____



Experience the Excellence
www.electroluxprofessional.com

Front

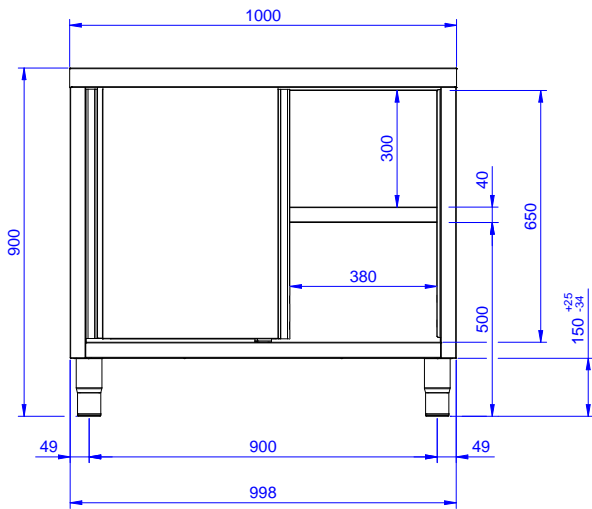

Side

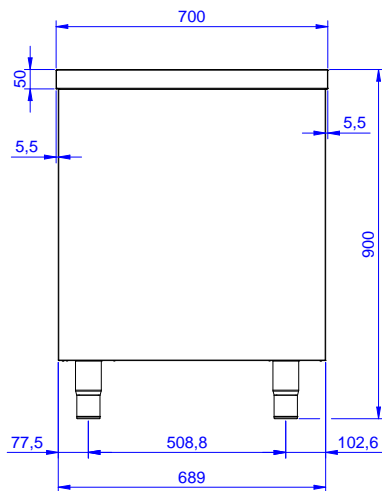

Top

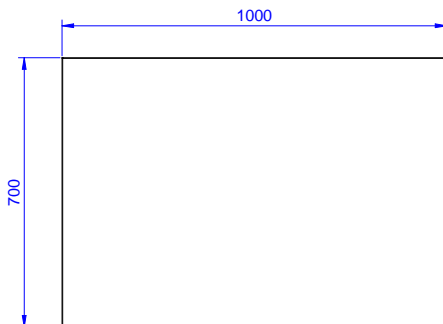

Key Information:

Cabinet width:	
132856 (MS1007N)	945 mm
Cabinet depth:	645 mm
Cabinet height:	610 mm
External dimensions, Width:	1000 mm
External dimensions, Depth:	700 mm
External dimensions, Height:	900 mm
Worktop thickness:	50 mm
Net weight:	50 kg